

Material: AL6063-T5
Profile Size: 120*50 mm
Manufacturer Code: D01-003
Surface: Anodised/CNC milling
Notes: Length customized according to drawings

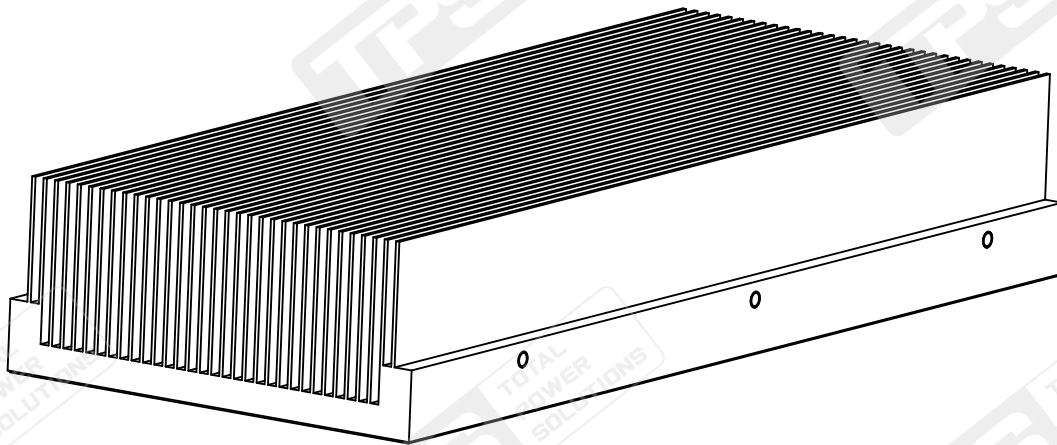

(Example)

